

CHECK VALVES CATALOG



American Made Quality since 1928





A history of Quality, Service and Innovation

Now in its ninth decade, Conbraco Industries, Inc. is a leading manufacturer of flow control products for U.S. and international markets. The company's headquarters is based in Matthews, North Carolina with manufacturing plants and foundries located in Pageland and Conway, South Carolina.

Conbraco has a history of new product development and innovation that dates back to the company's inception in 1928. Today, the Conbraco line of products is marketed under the "Apollo Valves" brand and includes: ball valves, butterfly valves, backflow prevention devices, water pressure reducing valves, mixing valves, safety relief valves, water gauges, strainers, actuation and APOLLOXPRESS® products.

Conbraco's vertically integrated manufacturing ensures a consistency of production, testing, quality and availability. You can be assured that Conbraco flow control products will deliver long term reliability. All manufacturing facilities are ISO 9001:2008 certified.

The Conbraco line continues to expand with new products, designs and advanced materials to better serve the needs of our customers. Markets served include: chemical processing, pulp and paper, petroleum, residential and commercial plumbing and heating, OEM, irrigation, water works, and fire protection.



PAGELAND, SC
Bronze Foundry and Manufacturing Plant



PAGELAND, SC
Final Assembly and Distribution Center



CONWAY, SC
Steel Foundry and Manufacturing Plant



MATTHEWS, NC
Corporate Headquarters

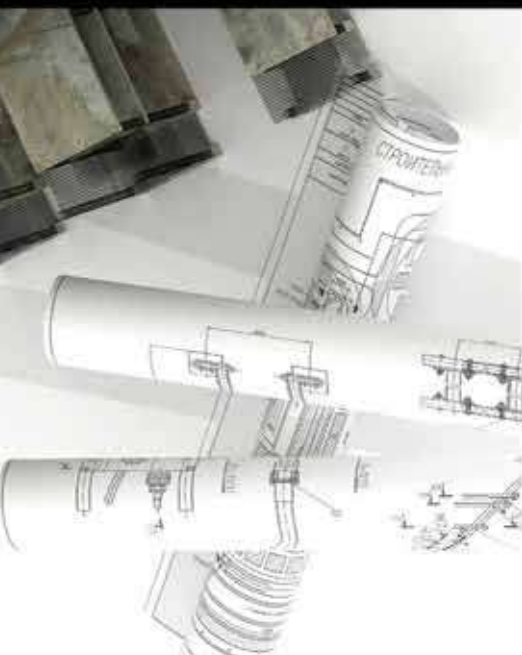

3D CAD Revit Models

www.apollovalves.com

**available formats:
revit, dwg, par, & sat**

Drawings also available for **LEAD FREE** models.

Throughout this catalog, products that have a Lead Free* option will be identified with this logo.



* **LEAD FREE:** The wetted surfaces of this product shall contain no more than 0.25% lead by weighted average. Complies with Federal Public Law 111-380. ANSI 3rd party approved and listed.

** Any imported products are clearly identified as "Apollo International™" or "Conbraco™ International".

Conbraco Industries offers a wide range of Apollo® products for potable and non-potable applications. When the use of lead free valves is required by code, specification or legislation, it is the sole responsibility of our customers to ensure that only lead free Apollo® products are installed in systems intended for potable water service. Further information related to our product offering and the **U.S. Safe Drinking Water Act (SDWA)** is available at www.apollovalves.com/lead_free, or by contacting Conbraco Customer Service.

TABLE OF CONTENTS

61-100 Series.....	4	70-100-BC Series.....	12
61-200 Series	4	Swing Check Valves	13
62-100 Series	5	61Y Series	14-15
Check Valve Part Numbering System.....	6, 7 & 10	6SC Series.....	16
61-500 / 61-600	7-8	6WC Series	17
62-500 Series	9-10	Repair Kits	18
61-700 Series.....	11	Warranty Information	19

PROTECTION AGAINST REVERSE FLOW

CHECK VALVES EXTEND SYSTEM LIFE

In any liquid or gas system where reverse flow cannot be tolerated, a quick-responding check valve is a necessity. Check valves that close slowly permit flow reversal to occur in the line which can cause severe mechanical shock. As the valve finally seats, high peak pressure pulses and shock waves are generated on the downstream side due to the media being forced to a sudden stop. Upstream, the momentum is not restricted which can create voids in the flow, filling with air or vapor to cause additional, lower frequency shock waves.

These shock waves added together are known as water hammer. It can cause extensive damage or failure to pipelines, gaskets, supports, hardware and equipment. The result can be expensive, troublesome; even dangerous.

With Apollo check valves, the potential for water hammer is greatly reduced since the check returns to its seat before flow velocity reaches zero. Apollo's check valves set the standard for compact, economical protection against reverse flow. They provide reliable service in liquids or gases at various temperature and pressure combinations. Because of their simple design, they're versatile and easy to maintain.

USE IN ANY POSITION

Horizontal, vertical or upside down; liquid, air and gases; Apollo's in-line checks operate in any orientation. Where frequent opening and closing cycles occur, vertical orientation with upward flow is best. This saves time and money, eliminating the need to stock separate vertical and horizontal-operating valves. It also makes new or replacement installation less of a headache.

BROAD RANGE OF APPLICATIONS

Apollo check valves are at home in applications from residential boilers to tough process systems, including:

- Evaporators
- Cookers
- Rubber/Plastic Presses
- Metering Pumps
- Boiler Feed
- Chiller Systems
- Autoclaves
- Casing Vents
- Water Lines
- Steam Tracer Lines
- Sterilizers
- Condensate Return Lines
- Steam Lines
- Salt Water Injection
- Air and Gas Lines
- Chemical Lines

Industries where Apollo's check valves are used include Pulp & Paper, Chemical Processing, Agrichemical, Rubber, Petroleum, Primary Metals, Mining, Power Generation, Textiles, Food and Beverage, Building Construction and Maintenance. Power Generation, Textiles, Food and Beverage, Building Construction and Maintenance.

IN-LINE(SILENT) CHECK VALVES

Series 61 and lead free (61LF) check valves feature bronze body construction and are available in sizes 1/4" to 3" for use with water, steam, oil, air and inert gases.

Series 62 model in stainless steel with investment cast body are sized from 1/4" to 2" for use in more severe applications and corrosive environments.

61 and 62 Series check valves are available with either RPTFE ball cone or elastomer soft seats. They come equipped with 316 stainless steel springs. All wetted parts are bronze/brass (61 Series) or stainless steel (62 Series).

SPRING ASSISTED CLOSING

Apollo's 61 and 62 Series feature short check travel and spring assisted closing. This ensures the valve closes quickly, before reversal of flow, helping to eliminate water hammer, its associated noise, and damage to piping and machinery.

LOW CRACKING PRESSURE

Apollo's standard 61 and 62 Series checks operate at low cracking pressures. An extra-light-spring version of the valve is available as an option. A 5-pound or 10-pound cracking pressure spring is also available on models through 1".

TIGHT... OR BUBBLE TIGHT

Patented Apollo Ball Cone® check valves (61-100, 61-200 and 62-100) feature a tight-sealing RPTFE ball-shaped check which seats against the conical interior face of the valve's metal retainer. This simple design provides exceptional resistance to wear and corrosion.

But where even tighter sealing is required, choose the 61-500 or 61-600, featuring EPDM (elastomer) seat or 62-500, featuring a Fluorocarbon (Viton®) seat, for a bubble-tight seal. A Nitrile seat is optional.

SWING CHECK VALVE

Swing Check Valves are the most common, and the best type check valve for general purpose application. Of all check valve designs, these valves produce the lowest pressure drop, when compared with other type of check valves of the same size. They feature a simple design that is easy to maintain inline.

It functions by allowing the flow forces to move the disc from the closed position to the fully open position in a sweeping arc motion against the hinge-stop inside of the valve body. Due to the weight and the center of gravity location of the disc and swing-arm assembly, the valve will return to the closed position should flow become interrupted or reversed. Bronze swing checks are available in sizes 1/4" to 3" with metal and soft seats. Cast iron swing checks and wafer checks are available in sizes 2" - 24".

QUALITY BUILT IN AMERICA

Bronze and stainless steel check valves are produced in the U.S. at our ISO 9001 registered manufacturing facilities to assure integrity of design and the highest level of performance. All Apollo check valves are 100% factory tested.



For additional information, submittal sheets and manuals, visit www.apollovalves.com

Customer Service (704) 841-6000

CHECK VALVES

Ball Cone® Check Valves

61 SERIES (MODEL CVB)



61-100
Female x Female Threaded
1/4" through 3"



61-200
Male x Female Threaded
1/4" through 2"

The Apollo Model CVB check valve with rugged bronze body and patented design (U.S. Pat. No. 4,172,465) RPTFE ball-cone check provides reliable protection against reverse flow. It is spring-loaded for fast seating and center guided for optimum alignment.

FEATURES

- 1/2 psi opening pressure
- Tight shut-off with liquid media
- 400 psig CWP
- 125 psig steam rating @350°F max
- Straight-through design
- American-made construction
- CRN OC 11218.5C
- **Lead Free Option** (model 61LF)

MATERIALS OF CONSTRUCTION

Body	Bronze - ASTM B584, UNS Alloy C84400
Retainer	Brass - ASTM B16, (1/4" – 1") Bronze - ASTM B584, (1-1/4" – 3")
Ball Check	RPTFE - Reinforced Teflon™
Guide	Brass - ASTM B16
Spring	Stainless Steel

Flow Rate (Cv)	
GPM=gallons per minute at 1 psi pressure differential	
Size	GPM
1/4"	0.85
3/8"	1.21
1/2"	1.4
3/4"	3.53
1"	6
1-1/4"	44
1-1/2"	65
2"	81
2-1/2"	175
3"	265

Pressure Temperature Ratings	
Degree (F)	PSIG
-20 to 100	400
200	200
250	160
275	150
300	140
325	130
353	125

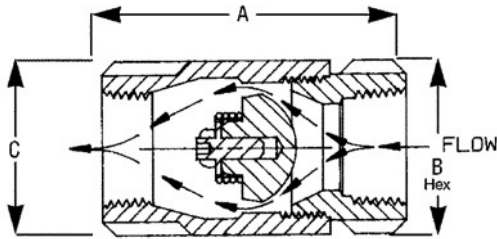

61-100

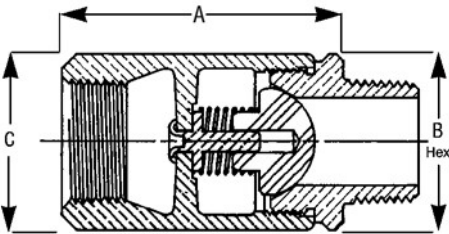

61-200

NOTE: Not recommended for use with reciprocating pumps and similar applications. Low flows may result in undesirable noise and premature valve failure. See page 6 for additional precautions.

Dimensional Specifications

Bronze FNPT x FNPT	LF Bronze FNPT x FNPT	Bronze MNPT x FNPT	Size	Dimensions (in.)			61-100 Series Wt./100	61-200 Series Wt./100
				A	B	C		
61-101-01	61LF-101-01	61-201-01	1/4"	2.06	1.12	1.12	38	38
61-102-01	61LF-102-01	61-202-01	3/8"	2.12	1.12	1.12	37	37
61-103-01	61LF-103-01	61-203-01	1/2"	2.31	1.12	1.12	36	36
61-104-01	61LF-104-01	61-204-01	3/4"	2.87	1.37	1.50	75	76
61-105-01	61LF-105-01	61-205-01	1"	3.50	1.75	1.93	145	145
61-106-01	61LF-106-01	61-206-01	1-1/4"	4.18	2.12	2.37	275	237
61-107-01	61LF-107-01	61-207-01	1-1/2"	4.93	2.50	2.81	394	381
61-108-01	61LF-108-01	61-208-01	2"	6.00	3.00	3.68	630	636
61-109-01	61LF-109-01	-	2-1/2"	7.00	3.50	4.50	1400	-
61-100-01	61LF-100-01	-	3"	8.12	4.12	5.31	1665	-

CHECK VALVES

Ball Cone® Check Valves

62 SERIES (MODEL CVS)



62-100
Female x Female Threaded
1/4" through 2"

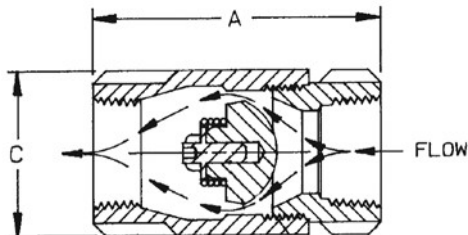
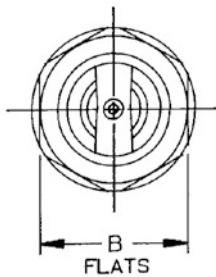

The Apollo Model CVS is uniquely suited for applications in corrosive environments, including chemical processing, pulp and paper and other process industries. The rugged stainless steel body and RPTFE ball cone check provide reliable, patented protection against reverse flow.

FEATURES

Unique (U.S. Patent #4,172,465) ball cone design provides tight shutoff in reverse flow conditions. The body of the valve is investment cast stainless steel for longer life in severe environments. It is spring-loaded for fast seating action and center guided so that radial alignment is never needed. Straight-through flow minimizes velocity change. It is rated 400 psig CWP, cold non-shock; 125 psig saturated steam. Opening pressure 1/2 psig.

MATERIALS OF CONSTRUCTION

Body	Stainless Steel - ASTM A351, CF8M
Retainer	Stainless Steel - ASTM A276, 316 (1/4" - 1") Stainless Steel - ASTM A351, CF8M (1-1/4" - 2")
Ball Check	RPTFE - Reinforced Teflon™
Guide	Stainless Steel - ASTM A276, 316
Spring	Stainless Steel

Flow Rate (Cv)	
GPM=gallons per minute at 1 psi pressure differential	
Size	GPM
1/4"	0.85
3/8"	1.21
1/2"	1.4
3/4"	3.53
1"	6
1-1/4"	44
1-1/2"	65
2"	81

Pressure Temperature Ratings	
Degree (F)	PSIG
-20 to 100	400
200	200
250	160
275	150
300	140
325	130
353	125

Dimensional Specifications

Item Number	Size	A	B	C	Wt./100
62-101-01	1/4"	2.06	1.12	1.12	38
62-102-01	3/8"	2.12	1.12	1.12	37
62-103-01	1/2"	2.31	1.12	1.12	36
62-104-01	3/4"	2.87	1.37	1.50	75
62-105-01	1"	3.50	1.75	1.93	145
62-106-01	1-1/4"	4.18	2.12	2.37	237
62-107-01	1-1/2"	4.93	2.50	2.81	381
62-108-01	2"	6.00	3.00	3.68	636

NOTE: Not recommended for use with reciprocating pumps and similar applications. Low flows may result in undesirable noise and premature valve failure. See page 6 for additional precautions.

CHECK VALVES

IN-LINE CHECK VALVES

CHECK VALVE PART NUMBERING SYSTEM – BALL CONE CHECK MODELS

6 X	- X	X	X	- XX
TYPE	CHECK	SPRING TYPE	SIZE (IN.)	OPTIONS
1 = Bronze	1 = Ball Cone (NPT-F x F)	0 = .5 psig Cracking Pressure	1 = 1/4"	01 = Standard
1LF = Lead Free Bronze	2 = Ball Cone (NPT-M x F)	2 = .2 psig Cracking Pressure	2 = 3/8"	P01 = BSPP Thread
2 = Stainless Steel	0 = Ball Cone Repair Kit		3 = 1/2"	T01 = BSPT Thread
			4 = 3/4"	17 = Satin Chrome Plated
			5 = 1"	57 = Oxygen Cleaned
			6 = 1-1/4"	A1 = Less Spring
			7 = 1-1/2"	E05 = 5 psig Opening Pressure*
			8 = 2"	E10 = 10 psig Opening Pressure*
			9 = 2-1/2"	
			0 = 3"	

*Available in 1/4" through 1" Only.

(Note: Not all combinations are available. Contact Customer Service for verification.)

NOTE: The Cv (Valve Constant) is the gallons of water per minute that the valve will pass with a 1 PSIG pressure drop across the valve.

FLOW OF LIQUID

$$Q = C_v \sqrt{\frac{\Delta P}{SpGr}}$$

$$\text{or } \Delta P = \frac{(Q)^2 (SpGr)}{(C_v)^2}$$

WHERE:

Q = flow in US gpm
 ΔP = pressure drop (PSI)
 SpGr = specific gravity at flowing temperature
 Cv = valve constant

FLOW OF GAS

$$Q = 1360 C_v \sqrt{\frac{\Delta P (P_2)}{(SpGr) (T)}}$$

$$\text{or } \Delta P = \frac{5.4 \times 10^{-7} (SpGr) (T) (Q)^2}{(C_v)^2 (P_2)}$$

WHERE:

Q = flow in SCFH
 ΔP = pressure drop (PSI)
 SpGr = specific gravity (based on air - 1.0)
 P_2 = outlet pressure - psia (psig + 14.7)
 T = (temp. °F + 460)
 Cv = valve constant

PRECAUTIONARY NOTE:

Not recommended for use with reciprocating pumps and similar applications which may induce repetitious vibrations. Low flow rates which do not fully open the valve, may result in undesirable noise and premature valve failure. Upstream flow disturbances, which create turbulence, may also result in rapid wear. Therefore, it is recommended that a minimum of 10 diameters of straight pipe be provided between the check valve and any upstream flow disturbances such as pumps, control valves, elbows, etc.

CHECK VALVES

Soft Seated Check Valves

61-500/61-600 SERIES (MODEL CVBE)



61-500
Female x Female Threaded
1/4" through 2"



61-600
Female x Female Sweat
1/2" through 2"

The Apollo Model CVBE check valve is ideally suited for hydronic heating and other low flow applications. The rugged bronze body and check provide reliable protection against reverse flow.

FEATURES

The 61-500/61-600 features an EPDM soft seat for bubble tight shutoff, reduced noise and less vibration. It is spring-loaded for fast seating action and center guided for optimum alignment. Straight-through flow minimizes velocity change. The spring is fully protected from the flow stream, helping extend the service life of the valve. The valve is rated 400 psig CWP, cold non-shock; Maximum Temperature 250°F. **Lead Free option** now available in select models and sizes. Opening pressure 1/2 psig.

MATERIALS OF CONSTRUCTION

Body	Bronze - ASTM B584, UNS Alloy C84400
Retainer	Brass - ASTM B16 (1/4" - 1") Bronze - ASTM B584 (1-1/4" - 2")
Seat	EPDM
Guide Pin	Stainless Steel
Spring	Stainless Steel
Check	Brass - ASTM B16
Guide	Brass - ASTM B16

Flow Rate (Cv)			
GPM=gallons per minute at 1 psi pressure differential			
61-500		61-600	
Size	GPM	Size	GPM
1/4"	0.85	-	-
3/8"	1.21	-	-
1/2"	1.4	1/2"	2.20
3/4"	3.53	3/4"	4.78
1"	6	1"	6
1-1/4"	44	1-1/4"	44
1-1/2"	65	1-1/2"	65
2"	81	2"	81

NOTE: Not recommended for use with reciprocating pumps and similar applications. Low flows may result in undesirable noise and premature valve failure. See page 6 for additional precautions.

CHECK VALVE PART NUMBERING SYSTEM – SOFT SEAT MODELS

6 X	- X	X	X	- XX
TYPE	CHECK	SPRING TYPE	SIZE (IN.)	OPTIONS
1 = Bronze 1LF = Lead Free Bronze	5 = Soft Seat (NPT-F x F) 6 = Soft Seat (Solder) 9 = Soft Seat Repair Kit (EPR only)	0 = .5 psig Cracking Pressure 2 = .2 psig Cracking Pressure	1 = 1/4" 2 = 3/8" 3 = 1/2" 4 = 3/4" 5 = 1"	01 = Standard (EPDM Seat) P01 = BSPP Thread (ISO 228) T01 = BSPT Thread (EN 10226) 17 = Satin Chrome Plated 57 = Oxygen Cleaned A1 = Less Spring B1 = Nitrile Seat V1 = Viton Seat E05 = 5 psig Opening Pressure* E10 = 10 psig Opening Pressure*

*Available in 1/4" through 1" Only.

(Note: Not all combinations are available. Contact Customer Service for verification.)



For additional information, submittal sheets and manuals, visit www.apollovalves.com

Customer Service (704) 841-6000

CHECK VALVES

Soft Seated Check Valves

61-500/61-600 SERIES BRONZE (CONT.)

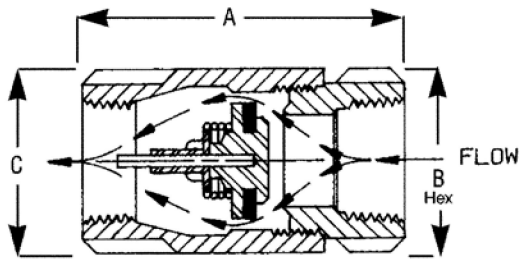
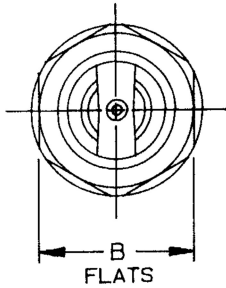

61-500

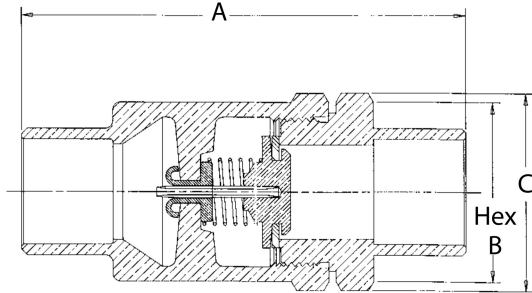

61-600

61-500 Dimensional Specifications

Item Number	LF Item Number	Size	A	B	C	Wt./100
61-501-01	61LF-501-01	1/4"	2.31	1.12	1.12	38
61-502-01	61LF-502-01	3/8"	2.31	1.12	1.12	37
61-503-01	61LF-503-01	1/2"	2.31	1.12	1.12	36
61-504-01	61LF-504-01	3/4"	2.87	1.37	1.50	75
61-505-01	61LF-505-01	1"	3.50	1.75	1.93	145
61-506-01	61LF-506-01	1-1/4"	4.18	2.12	2.37	275
61-507-01	61LF-507-01	1-1/2"	4.93	2.50	2.81	394
61-508-01	61LF-508-01	2"	6.00	3.00	3.68	630

61-600 Dimensional Specifications

Item Number	LF Item Number	Size	A	B	C	Wt./100
61-603-01	61LF-603-01	1/2"	2.75	1.12	1.25	38
61-604-01	61LF-604-01	3/4"	3.68	1.50	1.62	75
61-605-01	61LF-605-01	1"	4.50	1.93	2.12	145
61-606-01	61LF-606-01	1-1/4"	6.11	2.13	2.38	330
61-607-01	61LF-607-01	1-1/2"	6.87	2.50	2.81	610
61-608-01	61LF-608-01	2"	7.46	3.38	3.75	1010

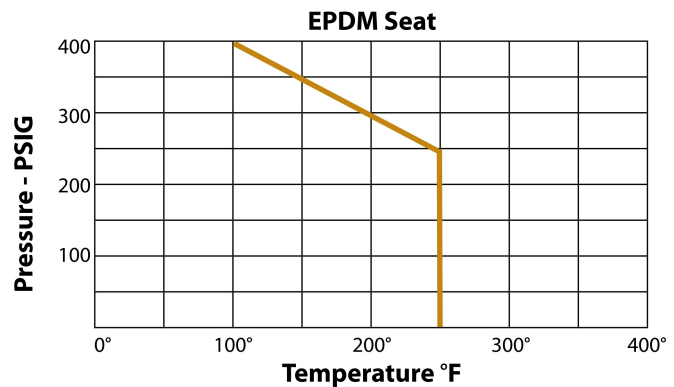

CHECK VALVES

Soft Seated Check Valves

62-500 SERIES (MODEL CVSE)



62-500
Female x Female Threaded
1/4" through 1"

The Apollo Model CVSE is ideal for fluid flow applications in tough industrial environments. The stainless steel body and check provide lasting protection against reverse flow.

The 62-500 features a Fluorocarbon (Viton®) soft seat for bubble tight shutoff, reduced noise and vibration. It is spring-loaded for fast seating action and center guided for optimum alignment. Straight-through flow minimizes velocity change. The spring is fully protected from the flow stream, helping extend the life of the valve. The 62-500 is rated 400 psig CWP, cold non-shock; Maximum Temperature 350°F.

FEATURES

- Bubble-tight shut-off, ideally suited for gaseous service
- 400 psig CWP non-shock
- Viton® check disc
- Approximate opening pressure 1/2 psi
- RoHS Compliant
- CRN OC 11218.5C

MATERIALS OF CONSTRUCTION

Body	Stainless Steel - ASTM A351,CF8M
Retainer	Stainless Steel - ASTM A276, 316
Seat	Fluorocarbon - Viton®
Spring	Stainless Steel - AISI 316
Check	Stainless Steel - ASTM A276, 316

Flow Rate (Cv)	
GPM=gallons per minute at 1 psi pressure differential	
Size	GPM
1/4"	0.47
3/8"	1.57
1/2"	2.20
3/4"	4.78
1"	6.00

NOTE: Not recommended for use with reciprocating pumps and similar applications. Low flows may result in undesirable noise and premature valve failure. See page 6 for additional precautions.

CHECK VALVES

Soft Seated Check Valves

62-500 SERIES (MODEL CVSE) (CONT.)

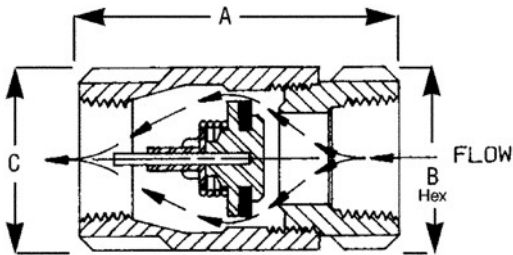

Dimensional Specifications

Item Number	Size	A	B	C	Wt./100
62-501-01	1/4"	2.312	1.125	1.125	38
62-502-01	3/8"	2.312	1.125	1.125	37
62-503-01	1/2"	2.312	1.125	1.125	36
62-504-01	3/4"	2.875	1.375	1.500	75
62-505-01	1"	3.500	1.750	1.937	150

NOTE: Not recommended for use with reciprocating pumps and similar applications. Low flows may result in undesirable noise and premature valve failure. See page 6 for additional precautions.

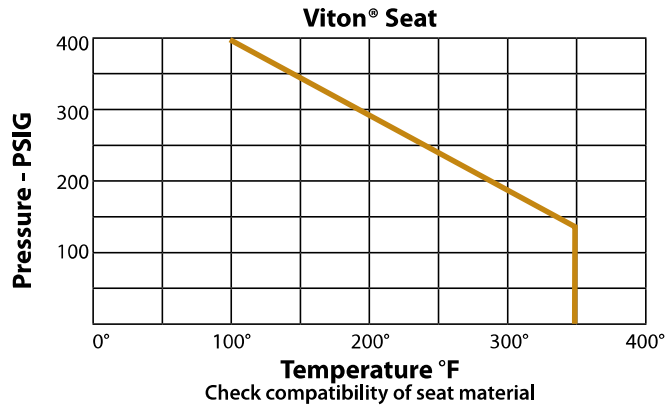

CHECK VALVE PART NUMBERING SYSTEM – SOFT SEAT MODELS

62	- X	X	X	- XX
TYPE	CHECK	SPRING TYPE	SIZE (IN.)	OPTIONS
62 = Stainless Steel	5 = Soft Seat (NPT-F x F) 6 = Soft Seat (Solder) 9 = Soft Seat Repair Kit (Viton only)	0 = .5 psig Cracking Pressure 2 = .2 psig Cracking Pressure	1 = 1/4" 2 = 3/8" 3 = 1/2" 4 = 3/4" 5 = 1"	01 = Standard (Viton seat) P01 = BSPP Thread (ISO 228) T01 = BSPT Thread (EN 10226) 17 = Satin Chrome Plated 57 = Oxygen Cleaned A1 = Less Spring B1 = Nitrile Seat F1 = EPDM Seat E05 = 5 psig Opening Pressure* E10 = 10 psig Opening Pressure*

*Available in 1/4" through 1" Only.

(Note: Not all combinations are available. Contact Customer Service for verification.)

CHECK VALVES

Mini Check Valves

61-700 SERIES (MODEL CV)



61-700
Female x Female Pipe Thread
1/4" through 1"

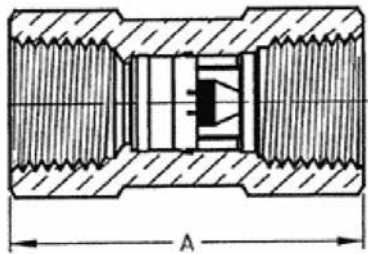
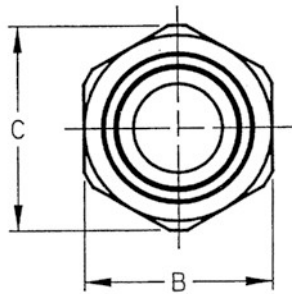

The Apollo Model CV check valve is ideally suited for cold water, and air applications for prevention of reverse flow. The modular check cartridge provides superior leak-tight performance with low pressure loss. It is rated at 230 PSIG with a maximum temperature of 200°F.

FEATURES

- 0.5 psi cracking pressure
- Acetyl silicone check with:
Silicone rubber seat (1/4 & 3/8)
Nitrile seat (1/2-1)

MATERIALS OF CONSTRUCTION

Body	Brass, ASTM B16
Check Module	Acetal/Brass/Silicone/Buna-N
Spring	Stainless Steel 302

Dimensional Specifications

Item Number	Size	A	B	C	Wt./100
61-701-01	1/4"	1.72	0.81	0.92	22
61-702-01	3/8"	1.79	0.93	1.05	29
61-703-01	1/2"	2.02	1.06	1.17	38
61-704-01	3/4"	2.50	1.25	1.40	54
61-705-01	1"	2.95	1.62	1.76	110

Flow Rate (Cv)	
GPM=gallons per minute at 1 psi pressure differential	
Size	GPM
1/4"	0.78
3/8"	1.81
1/2"	6.00
3/4"	11.50
1"	17.50

NOTE: Not recommended for use with reciprocating pumps and similar applications. Low flows may result in undesirable noise and premature valve failure. See page 6 for additional precautions.

CHECK VALVES

Ball Valve with Integral Check

70-100-BC



70-100-BC
Female x Female Threaded
1/2" through 2"

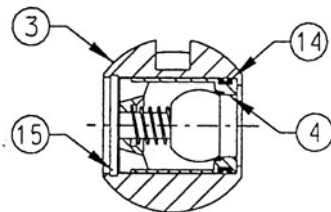
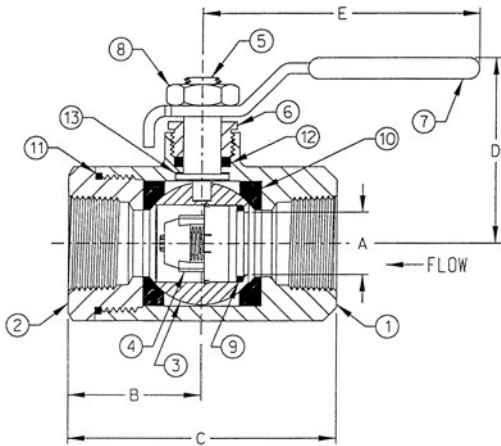

The 70-100-BC Series ball valve combines two functions in a single design: positive shut-off and bubble-tight check capabilities. The BC Series is a unidirectional version of the industry-standard Apollo 70 Series ball valve. An easy flow design and superior check valve make these valves a smart choice for water or air in mechanical systems or OEM applications. Rated at 250 psi WOG and maximum temperature of 200°F.

FEATURES

- Blowout-proof stems
- RPTFE seats and stuffing box ring
- Adjustable packing gland
- Chromium-plated ball
- Positive shut-off and bubble-tight check capability

MATERIALS OF CONSTRUCTION

1	Body	B584-C84400
2	Retainer	B16 (1/2"-1") B584-C84400 (1-1/4"-2")
3	Ball	B16 Brass Chrome Plated
4	Check Valve Insert	Acetal
5	Stem	B16 Brass
6	Gland Nut	B16 Brass
7	Lever and Grip	Steel, Zinc-plated w/vinyl
8	Lever Nut	Steel, Zinc-plated
9	O-Ring	Buna-N
10	Seat (2)	Reinforced TFE
11	Body Seal	TFE (1-1/4" - 2")
12	Stem Packing	Reinforced TFE
13	Stem Bearing	Reinforced TFE
14	Seal	EPDM (1/2")
15	Retaining Ring	Spring Steel (1/2")

Dimensional Specifications

Item Number	Size	A	B	C	D	E	Wt./100
70-103-BC	1/2"	0.50	1.12	2.25	1.80	3.87	0.63
70-104-BC	3/4"	0.68	4.50	3.00	2.12	4.87	1.33
70-105-BC	1"	0.87	1.68	3.37	2.25	4.87	1.77
70-106-BC	1-1/4"	1.00	2.00	4.00	2.73	5.50	3.29
70-107-BC	1-1/2"	1.25	2.18	4.37	3.09	8.00	4.63
70-108-BC	2"	1.50	2.34	4.68	3.28	8.00	6.01

RTFE Seats

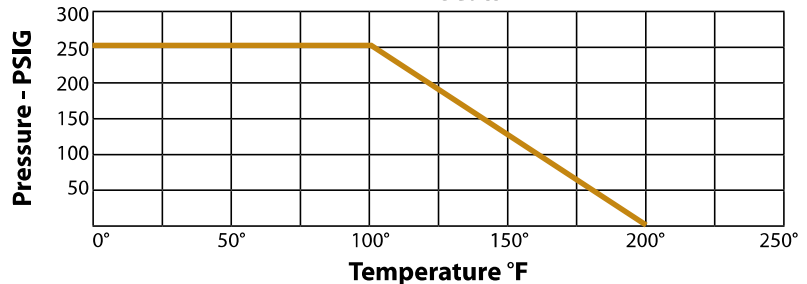

NOTE: Not recommended for use with reciprocating pumps and similar applications. Low flows may result in undesirable noise and premature valve failure. See page 6 for additional precautions.

CHECK VALVES

SWING CHECK VALVES

SIZING

It is very important to optimally size check valves in order to maximize the piping system efficiencies, and minimize or eliminate check valve maintenance. If the check valves are sized too small, they produce excessive pressure drop, reduce flow and/or require increased pump energy. If the check valves are sized too large, the disc will not be fully open and the disc assembly will be unstable. The instability causes premature wear of associated moving components requiring increased maintenance or even failure of the valve.

The common practice in piping is to size a check valve to fit the pipe size. However, properly sizing a check valve requires a thorough knowledge of all piping system flow conditions (type of fluid, temperature, pressure and flow rate) as well as leakage rates, flow coefficient and cracking pressure. Properly sized check valves frequently are smaller than the pipe in which they are used. This practice keeps velocities up so the valve operates near full open, minimizing noise and vibration while maximizing valve life.

Below is a table showing minimum velocity (ft/sec.) necessary to hold the disc in a fully open position and stable condition. Also, the actual flowrates (Cv) at a 1.0 psid across the valve.

SWING CHECK VALVE SIZE	(D1) PORT DIAMETER (IN.)	(D2) SCH. 40 PIPE INSIDE DIAMETER (IN.)	RATIO (D1/D2)	MINIMUM VELOCITY (FT/SEC)	Cv (gpm) @ 1.0 PSID
1/4"	0.616	0.364	1.692	7.5155	2.61
3/8"	0.616	0.493	1.249	5.5490	4.50
1/2"	0.616	0.622	0.990	4.3982	6.94
3/4"	0.755	0.824	0.916	4.0691	12.03
1"	1.021	1.049	0.973	4.3225	28.55
1-1/4"	1.255	1.380	0.909	4.0387	39.00
1-1/2"	1.505	1.610	0.935	4.1514	56.00
2"	2.005	2.067	0.970	4.3078	152.00
2-1/2"	2.505	2.469	1.015	4.5058	198.00
3"	3.005	3.068	0.979	4.3498	242.00

Where:

Minimum Velocity (ft/sec) for full disc opening = (Ratio)²(35)(√specific volume)

Specific volume of water at 100°F = 0.0161 cuft/lb.

PRECAUTIONARY NOTE:

Not recommended for use with reciprocating pumps and similar applications which may induce repetitious vibrations. Low flow rates which do not fully open the valve, may result in undesirable noise and premature valve failure. Upstream flow disturbances, which create turbulence, may also result in rapid wear. Therefore, it is recommended that a minimum of 10 diameters of straight pipe be provided between the check valve and any upstream flow disturbances such as pumps, control valves, elbows, etc.



For additional information, submittal sheets and manuals, visit www.apollovalves.com

Customer Service (704) 841-6000

CHECK VALVES

Swing Check Valves

61Y SERIES



Solder



NPT

PERFORMANCE RATING:

Saturated Steam: 125 psi (8.6 Bar) to 353°F (178°C)
CWP: 200 psi (13.8 Bar) at 100°F
Temp. Range: -20°F to 406°F

CLASS 125

The Apollo Swing Checks provides a cost effective “made in the USA” alternative to globally sourced check valves. These valves are cast, machined, assembled, and tested in South Carolina. The Apollo Swing Check can be installed in both horizontal or vertical line with upward flow. Bronze Disc, Solder.

FEATURES

- Renewable Seat Disc
- Metal Seat
- Dezincification Resistant Bronze
- 100% Factory tested
- Solder Connections
- 100% machined and assembled in US
- **Lead Free Option** (model 61YLF)

MATERIALS OF CONSTRUCTION

Body	Bronze, ASTM B62
Cap	Bronze, ASTM B62
Hanger	Stainless Steel
Pin	Stainless Steel
Seat*	Bronze, ASTM B62
Plug	Brass

* PTFE and Viton seat option

APPROVALS

- Standard - MSS SP-80
- Lead Free - MSS SP-139
- CRN OC 14667.5

Lead Free

Bronze, ASTM B584-C89836
 Bronze, ASTM B584-C89836
 Stainless Steel
 Stainless Steel
 Bronze, ASTM B584-C89836

WARNING: Do not use in reciprocating compressor service. See page 13 for additional precautions.

Dimensional Specifications (Solder)

161S Item Number (Metal)	161S-LF Item Number (Metal)	163S Item Number (Metal)	163S-LF Item Number (Metal)	Size	Height	Length	Wt./100
61Y-093-01	61YLF-093-01	61Y-103-T1	61YLF-103-T1	1/2"	1.65	2.53	.62
61Y-094-01	61YLF-094-01	61Y-104-T1	61YLF-104-T1	3/4"	1.9	3.36	.91
61Y-095-01	61YLF-095-01	61Y-105-T1	61YLF-105-T1	1"	2.26	4.07	1.7
61Y-096-01	61YLF-096-01	61Y-106-T1	61YLF-106-T1	1-1/4"	2.99	5.28	3.2
61Y-097-01	61YLF-097-01	61Y-107-T1	61YLF-107-T1	1-1/2"	2.99	5.28	2.7
61Y-098-01	61YLF-098-01	61Y-108-T1	61YLF-108-T1	2"	3.74	6.50	4.9
61Y-099-01	-	61Y-109-T1	-	2-1/2"	5.11	8.30	9.7
61Y-090-01	-	61Y-100-T1	-	3"	6.05	9.58	15.0

Height is measured from centerline to top of access cap.

Dimensional Specifications (NPT)

161T Item Number (Metal)	161T-LF Item Number (Metal)	162T Item Number (Viton)	163T Item Number (PTFE)	163T-LF Item Number (PTFE)	Size	Height	Length	Wt./100
61Y-191-01	61YLF-191-01	61Y-201-V1	61Y-201-T1	-	1/4"	1.51	2.14	.64
61Y-192-01	61YLF-192-01	61Y-202-V1	61Y-202-T1	-	3/8"	1.51	2.14	.62
61Y-193-01	61YLF-193-01	61Y-203-V1	61Y-203-T1	61YLF-203-T1	1/2"	1.65	2.48	.73
61Y-194-01	61YLF-194-01	61Y-204-V1	61Y-204-T1	61YLF-204-T1	3/4"	1.9	2.94	1.06
61Y-195-01	61YLF-195-01	61Y-205-V1	61Y-205-T1	61YLF-205-T1	1"	2.26	3.57	1.7
61Y-196-01	61YLF-196-01	61Y-206-V1	61Y-206-T1	61YLF-206-T1	1-1/4"	2.99	4.50	3.3
61Y-197-01	61YLF-197-01	61Y-207-V1	61Y-207-T1	61YLF-207-T1	1-1/2"	2.99	4.50	3.1
61Y-198-01	61YLF-198-01	61Y-208-V1	61Y-208-T1	61YLF-208-T1	2"	3.74	5.25	5.5
61Y-199-01	-	-	-	-	2-1/2"	5.11	8.00	11.7
61Y-190-01	-	-	-	-	3"	6.05	9.24	17.8

Height is measured from centerline to top of access cap.

www.apollovalves.com

Customer Service (704) 841-6000



CHECK VALVES

Swing Check Valves

61Y SERIES



PERFORMANCE RATING:

Saturated Steam: 150 psi (10.4 Bar)
to 366°F (185°C)
CWP: 300 psi (20.7 Bar)
at 100°F
Temp. Range: -20°F to 406°F

CLASS 150

The Apollo Model 164 Swing Check provides a cost effective “made in the USA” alternative to globally sourced check valves. These valves are cast, machined, assembled, and tested in South Carolina. The Apollo Swing Check can be installed in both horizontal or vertical line with upward flow. Bronze Seat, NPT.

FEATURES

- Renewable Seat Disc
- Metal Seat
- Dezincification Resistant Bronze
- 100% Factory tested
- NPT Connections
- 100% manufactured in USA

MATERIALS OF CONSTRUCTION

Body & Cap Bronze ASTM B62
Hanger & Pin Stainless Steel
Seat Bronze ASTM B62
Plug Brass

WARNING: Do not use in reciprocating compressor service. See page 13 for additional precautions.

Dimensional Specifications

164T Item Number (Metal)	Size	Height	Length	Wt./100
61Y-211-01	1/4"	1.51	2.14	.64
61Y-212-01	3/8"	1.51	2.14	.62
61Y-213-01	1/2"	1.65	2.48	.73
61Y-214-01	3/4"	1.90	2.94	1.06
61Y-215-01	1"	2.26	3.57	1.70
61Y-216-01	1-1/4"	2.99	4.50	3.40
61Y-217-01	1-1/2"	2.99	4.50	3.10
61Y-218-01	2"	3.74	5.25	5.50
61Y-219-01	2-1/2"	5.11	8.00	11.70
61Y-210-01	3"	6.05	9.24	17.80

Height is measured from centerline to top of access cap.

61Y SERIES



PERFORMANCE RATING:

Saturated Steam: 300 psi (20.7 Bar)
CWP: 600 psi (41.4 Bar)
at 100°F (38°C)
Temp. Range: -20°F to 422°F
(-29°C to 216°C)

CLASS 300

FEATURES

- Y-Pattern
- Bronze Disc / PTFE Disc
- NPT

MATERIALS OF CONSTRUCTION

Body & Cap Bronze ASTM B61
Hanger & Pin Stainless Steel
Seat Bronze ASTM B61 PTFE
Plug Brass

Dimensional Specifications

168T Item Number (Metal)	169T Item Number (PTFE)	Size	Height	Length	Wt./100
61Y-753-01	61Y-753-T1	1/2"	1.65	2.50	.75
61Y-754-01	61Y-754-T1	3/4"	1.90	2.95	1.20
61Y-755-01	61Y-755-T1	1"	2.27	3.57	1.80
61Y-756-01	61Y-756-T1	1-1/4"	3.00	4.50	3.50
61Y-757-01	61Y-757-T1	1-1/2"	3.00	4.50	3.20
61Y-758-01	61Y-758-T1	2"	3.75	5.25	5.60

Height is measured from centerline to top of access cap.



For additional information, submittal sheets and manuals, visit www.apollovalves.com

Customer Service (704) 841-6000

CHECK VALVES

Swing Check Valves

6SC SERIES

**Model
910F**



910F Class 125
910FLW Class 125
Lever & Weight Design
920F Class 250

**Model
910FLW**



The Apollo International™ Model 910 and 920 Flanged Cast Iron Swing Check valves provide full flow capabilities. They provide reliable and economical protection against reverse flow. The Apollo Swing Check valves can reliably be installed in most plumbing and heating systems including building service piping. Flanged connection with bolted bonnet for easy access to internals.

FEATURES

- Compatible with ANSI 125# & 150# Flanges
- Full Port
- Minimal Pressure Drop
- Flanged Connection
- Bolted Bonnet
- Integral Bronze Seat
- MSS SP-71 approval

MATERIALS OF CONSTRUCTION

Body	Cast Iron (ASTM A126 CL-B)
Bonnet	Cast Iron (ASTM A126 CL-B)
Bolts	Steel (ASTM A307 B)
Nameplate	Aluminum
Body Gasket	Graphite
Nuts	Steel (ASTM A307 B)
Side Plug	Brass (ASTM B16)
Gasket	Graphite
Hanger Pin	Brass (ASTM B16)
Hanger	Ductile Iron (ASTM A536 65-45-12)
Disc Ring	Cast Bronze (2"-6") Cast Iron (8"-20")
Disc	Cast Iron (ASTM A126 CL-B)
Washer	Steel (ASTM A307 B)
Split Pin	Stainless Steel (ASTM 420 S42000)
Seat Ring	Cast Bronze (2"-6") Cast Iron (8"-20")
Disc Nut	Steel (ASTM A307 B)
Stud Bolt	Steel (ASTM A307 B)

WARNING: Do not use in reciprocating compressor service. See page 13 for additional precautions.

Dimensional Specifications

910F Number	910FLW Number	920F Number	Size	Height	Length 910F & 910FLW	Length 920F	Wt. 910F	Wt. 910FLW	Wt. 920F
6SC-108-B1	6SC-108-B1L	6SC-208-B1	2"	4.41	8.00	10.51	26	39	30
6SC-109-B1	6SC-109-B1L	6SC-209-B1	2-1/2"	5.24	8.50	11.50	39	45	44
6SC-100-B1	6SC-100-B1L	6SC-200-B1	3"	5.67	9.50	12.50	47	63	55
6SC-10A-B1	6SC-10A-B1L	6SC-20A-B1	4"	6.61	11.50	14.00	82	99	90
6SC-10B-B1	6SC-10B-B1L	6SC-20B-B1	5"	7.80	13.00	15.75	124	132	135
6SC-10C-B1	6SC-10C-B1L	6SC-20C-B1	6"	8.54	14.00	17.50	160	170	172
6SC-10E-01	6SC-10E-01L	6SC-20E-01	8"	10.28	19.50	21.00	271	282	289
6SC-10G-01	6SC-10G-01L		10"	11.30	24.50		437	439	
6SC-10H-01	6SC-10H-01L		12"	12.56	27.50		644	672	
6SC-10J-01			14"	17.50	31.00		950		
6SC-10K-01			16"	23.45	36.00		1160		
6SC-10M-01			18"	27.50	36.00		1720		
6SC-10N-01			20"	29.25	40.00		2094		

CHECK VALVES

Wafer Check Valves

6WC SERIES



The Apollo International™ Model 910WB and 910WE Cast Iron Wafer Check valves provide full flow capabilities. It provides reliable and economical protection against reverse flow. The Apollo Wafer Check valve can reliably be installed in most plumbing and heating systems including building service piping. Wafer flanged connection.

FEATURES

- Wafer Flanged Connection
- Compatible with ANSI 125# & 150# Flanges
- Full Port
- Minimal Pressure Drop
- Light Weight
- Spring Assisted Closing for Quicker Response

MATERIALS OF CONSTRUCTION

Body	Cast Iron (ASTM A126 CL-B)
Seat Ring	EPDM (910WE)
Seat Ring	Nitrile (Buna-N) (910WB)
Disc	Aluminum Bronze
Spring	Stainless Steel 316
Stem	Stainless Steel 316
Screw	Carbon Steel
Pin	Stainless Steel 316

PERFORMANCE RATING:

MODEL 910WB

CWP: 200 psi (13.8 Bar) at 100°F (2-12")
150 psi (10.3 Bar) at 100°F (14-24")

Temp. Range: 10°F to 180°F

MODEL 910WE

CWP: 200 psi (13.8 Bar) at 100°F (2-12")

Temp. Range: -30°F to 275°F

WARNING: Do not use in reciprocating compressor service. See page 13 for additional precautions.

910WB & 910WE Dimensional Specifications

910WB Number	910WE Number	Size	Diameter	Length	Wt.	Max. Cracking Pressure (psi)
6WC-108-N1	6WC-108-E1	2"	4.00	2.12	5	0.70
6WC-109-N1	6WC-109-E1	2-1/2"	4.75	2.38	7	0.70
6WC-100-N1	6WC-100-E1	3"	5.25	2.62	10	0.70
6WC-10A-N1	6WC-10A-E1	4"	6.75	2.62	12	0.70
6WC-10B-N1	6WC-10B-E1	5"	7.50	3.25	15	0.70
6WC-10C-N1	6WC-10C-E1	6"	8.50	3.75	22	0.70
6WC-10E-N1	6WC-10E-E1	8"	11.00	5.00	35	0.70
6WC-10G-N1	6WC-10G-E1	10"	13.25	5.50	66	0.70
6WC-10H-N1	6WC-10H-E1	12"	16.00	7.12	108	0.70
6WC-10J-N1		14"	17.75	7.25	172	1.00
6WC-10K-N1		16"	20.00	7.50	132	1.00
6WC-10M-N1		18"	21.50	8.00	223	1.00
6WC-10N-N1		20"	23.75	8.38	333	1.00
6WC-10P-N1		24"	28.00	8.75	474	1.00

CHECK VALVES

Repair Kits

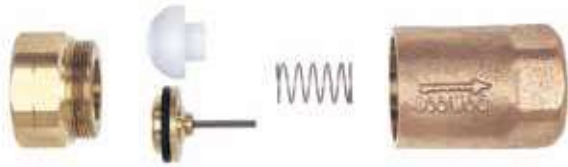

61-100/61LF-100 REPAIR KITS INCLUDE: SPRING, BALL CONE CHECK & INSTRUCTIONS

Size (in.)	Check Valve Part Number	LF Check Valve Part Number	Repair Kit Part Number
1/4"	61-101-01	61LF-101-01	61-001-01
3/8"	61-102-01	61LF-102-01	61-002-01
1/2"	61-103-01	61LF-103-01	61-003-01
3/4"	61-104-01	61LF-104-01	61-004-01
1"	61-105-01	61LF-105-01	61-005-01
1-1/4"	61-106-01	61LF-106-01	61-006-01
1-1/2"	61-107-01	61LF-107-01	61-007-01
2"	61-108-01	61LF-108-01	61-008-01
2-1/2"	61-109-01	61LF-109-01	61-009-01
3"	61-100-01	61LF-100-01	61-010-01

61-200 REPAIR KITS INCLUDE: SPRING, BALL CONE CHECK & INSTRUCTIONS

Size (in.)	Check Valve Part Number	Repair Kit Part Number
1/4"	61-201-01	61-001-01
3/8"	61-202-01	61-002-01
1/2"	61-203-01	61-003-01
3/4"	61-204-01	61-004-01
1"	61-205-01	61-005-01
1-1/4"	61-206-01	61-006-01
1-1/2"	61-207-01	61-007-01
2"	61-208-01	61-008-01

61-500/61LF-500 REPAIR KITS INCLUDE: SPRING, CHECK ASSEMBLY & INSTRUCTIONS

Size (in.)	Check Valve Part Number	LF Check Valve Part Number	Repair Kit Part Number
1/4"	61-501-01	61LF-501-01	61-901-01
3/8"	61-502-01	61LF-502-01	61-902-01
1/2"	61-503-01	61LF-503-01	61-903-01
3/4"	61-504-01	61LF-504-01	61-904-01
1"	61-505-01	61LF-505-01	61-905-01
1-1/4"	61-506-01	—	61-906-01
1-1/2"	61-507-01	—	61-907-01
2"	61-508-01	—	61-908-01

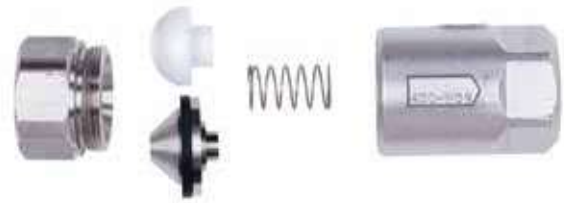

61-600 REPAIR KITS INCLUDE: SPRING, CHECK ASSEMBLY & INSTRUCTIONS

Size (in.)	Check Valve Part Number	Repair Kit Part Number
1/2"	61-603-01	61-903-01
3/4"	61-604-01	61-904-01
1"	61-605-01	61-905-01
1-1/4"	61-606-01	61-906-01
1-1/2"	61-607-01	61-907-01
2"	61-608-01	61-908-01

62-100 REPAIR KITS INCLUDE: SPRING, BALL CONE CHECK & INSTRUCTIONS

Size (in.)	Check Valve Part Number	Repair Kit Part Number
1/4"	62-101-01	62-001-01
3/8"	62-102-01	62-002-01
1/2"	62-103-01	62-003-01
3/4"	62-104-01	62-004-01
1"	62-105-01	62-005-01
1-1/4"	62-106-01	62-006-01
1-1/2"	62-107-01	62-007-01
2"	62-108-01	62-008-01

62-500 REPAIR KITS INCLUDE: SPRING, CHECK ASSEMBLY & INSTRUCTIONS

Size (in.)	Check Valve Part Number	Repair Kit Part Number
1/4"	62-501-01	62-901-01
3/8"	62-502-01	62-902-01
1/2"	62-503-01	62-903-01
3/4"	62-504-01	62-904-01
1"	62-505-01	62-905-01

WARRANTY AND LIMITATIONS OF LIABILITY

Conbraco Industries, Inc. warrants, to its initial purchaser only, that its products which are delivered to this initial purchaser will be of the kind described in the order or price list and will be free of defects in workmanship or material for a period of **FIVE** years from the date of delivery to you, our initial purchaser. This warranty applies to Apollo brand product with "Made in the USA" markings only.

Should any failure to conform to this warranty appear within **FIVE** years after the date of the initial delivery to our initial purchaser, Conbraco will, upon written notification thereof and substantiation that the goods have been stored, installed, maintained and operated in accordance with Conbraco's recommendations and standard industry practice, correct such defects by suitable repair or replacement at Conbraco's own expense.

APOLLO INTERNATIONAL PRODUCTS: Conbraco Industries, Inc. warrants its International products, to its initial purchaser only, that its international products which are delivered to this initial purchaser will be of the kind described in the order or price list and will be free of defects in workmanship or material for a period of **TWO** years from the date of delivery to you, our initial purchaser.

THIS WARRANTY IS EXCLUSIVE AND IS IN LIEU OF ANY IMPLIED WARRANTY OF MERCHANTABILITY, FITNESS FOR A PARTICULAR PURPOSE OR OTHER WARRANTY OF QUALITY, WHETHER EXPRESSED OR IMPLIED, EXCEPT THE WARRANTY OF TITLE AND AGAINST PATENT INFRINGEMENT. Correction of non-conformities, in the manner and for the period of time provided above, shall constitute fulfillment of all liabilities of Conbraco to our initial purchaser, with respect to the goods, whether based on contract, negligence, strict tort or otherwise. It is the intention of Conbraco Industries, Inc. that no warranty of any kind, whether expressed or implied shall pass through our initial purchaser to any other person or corporation.

LIMITATION OF LIABILITY: Conbraco Industries, inc. SHALL NOT UNDER ANY CIRCUMSTANCES BE LIABLE FOR SPECIAL OR CONSEQUENTIAL DAMAGES SUCH AS, BUT NOT LIMITED TO, DAMAGES OR TO LOSS OF OTHER PROPERTY OR EQUIPMENT, LOSS OF PROFITS OR REVENUE, COST OF CAPITAL, COST OF PURCHASED OR REPLACEMENT GOODS, OR CLAIMS OF CUSTOMERS OF OUR INITIAL PURCHASER. THE REMEDIES OF OUR INITIAL PURCHASER, AND ALL OTHERS, SET FORTH HEREIN, ARE EXCLUSIVE, AND THE LIABILITY OF CONBRACO WITH RESPECT TO SAME SHALL NOT, EXCEPT AS EXPRESSLY PROVIDED HEREIN, EXCEED THE PRICE OF THE GOODS UPON WHICH SUCH LIABILITY IS BASED.

* It is the end user's responsibility to confirm that items intended for use satisfy local codes and standards.





SALES & CUSTOMER SERVICE:
 Phone: (704) 841-6000 Fax: (704) 841-6020

To find a Sales Rep in your area, visit our website.
www.apollovalves.com/relocator

REGIONAL MANAGEMENT – APOLLO VALVES, ELKHART PRODUCTS & LASCO FITTINGS

	AREAS COVERED	EMAIL	PHONE
SENIOR MANAGEMENT			
Brian Ragone	Senior VP - Sales & Marketing	brian.ragone@conbraco.com	513-200-5415
Don Russell	VP Sales - Commercial & Industrial	don.russell@conbraco.com	614-943-0688

REGIONAL SALES DIRECTORS – COMMERCIAL & INDUSTRIAL			
Mike Bedzyk	Central/Northeast	michael.bedzyk@conbraco.com	614-619-4993
Mitch Davis	S. Central/Southeast	mitch.davis@conbraco.com	678-628-4478
Phillip Merino	West	phillip.merino@conbraco.com	702-960-9935

REGIONAL SALES MANAGERS – COMMERCIAL & INDUSTRIAL			
Kevin Ashworth	Southeast	kevin.ashworth@conbraco.com	757-272-6200
Keith Baca	Southeast	keith.baca@conbraco.com	615-630-3892
Mike Blair	Central	mike.blair@conbraco.com	330-413-0035
Steve Brown	Northwest	steve.brown@conbraco.com	425-985-5095
Ken Copeland	Southwest	ken.copeland@conbraco.com	623-853-5744
Ben Lauletta	Northeast	ben.lauletta@conbraco.com	518-795-4629
Wesley Reinart	S. Central	wesley.reinart@conbraco.com	214-620-9901

INDUSTRIAL MARKET MANAGERS			
Dave Eck	Northeast	david.eck@conbraco.com	302-268-4411
Ken Griffin	Industrial & Commercial Valve Trainer	ken.griffin@conbraco.com	704-621-9296
Mark Sordelet	Central	mark.sordelet@conbraco.com	260-433-7393
Skip Wilson	Northwest	skip.wilson@conbraco.com	760-518-2222

BACKFLOW MARKET MANAGERS			
Pete Chapman	National Manager	pete.chapman@conbraco.com	559-577-2593
Cary Wiley	East	cary.wiley@conbraco.com	678-642-3356

APOLLOXPRESS MARKET MANAGERS			
John Rankel	National Manager	john.rankel@conbraco.com	702-445-0309
Todd Green	South Central	todd.green@conbraco.com	501-920-2029
Brian Jennings	North Central	brian.jennings@conbraco.com	859-394-3319
Robert Purchia	East	robert.purchia@conbraco.com	704-960-3532

	AREAS COVERED	EMAIL	PHONE
APOLLOPUSH MARKET MANAGERS			
George Dragosz	Northeast	george.dragosz@elkhartproducts.com	574-206-3953
Mark Schanback	Southeast	mark.schanback@conbraco.com	407-916-9626
Jeremy Small	Central	jeremy.small@conbraco.com	214-766-2106
Dean Weidlein	West	dean.weidlein@elkhartproducts.com	702-355-8615

WROT/CAST MARKET MANAGERS			
Cindy Goodwin	National Manager	cindy.goodwin@elkhartproducts.com	517-294-0007

CANADA			
Jeff Cooper	General Manager	jeff.cooper@conbraco.com	416-451-9336
Andy Fretz	Commercial	andy.fretz@conbraco.com	647-281-3161
Jim Todman	Industrial	jim.todman@conbraco.com	905-407-8385

LASCO FITTINGS REGIONAL SALES MANAGERS – IRRIGATION			
David Beyer	Northeast	dbeyer@lascofittings.com	561-718-9379
Don Caver	Central	dcaver@lascofittings.com	469-628-4918
Ben Freeman	Southeast	bfreeman@lascofittings.com	205-919-4944
Bryan Jackman	West	bjackman@lascofittings.com	714-673-5875
Jimmy White	National Sales Manager	jwhite@lascofittings.com	731-234-2372
Rick Williamson	Eastern Specifications Manager	rwilliamson@lascofittings.com	386-451-2307

INTERNATIONAL SALES MANAGERS			
Bill McNamara	Director of International Sales	bil.mcnamara@elkhartproducts.com	1-574-903-3821
JR Jefferson	Central/South America & the Caribbean	jr.jefferson@conbraco.com	1-832-220-3783
Brencliff Group	Australia, New Zealand	petermd@brencliff.com	61 477 223110
Pegler Yorkshire	United Kingdom	adrian.byrne@conbraco.com	44-7740-449858
Pegler Yorkshire Mid East	Middle East/India	peter.pydubai@gmail.com	971-4-454-2353
	Europe/Africa/Israel	customersupport@conbraco.com	1-704-841-6000

current as of 7/20/15

For more information about **Apollo Valves, Elkhart Products Corporation**, and our family of **AMERICAN MADE** products, contact:

