

Pos.	Code no.	No. of parts	Notes
1	P0005173	1	
2	P0005172	1	
3	83130000	1	
4	P0005171	1	
5	86465525	9	
6	P0005170	1	
7	01307099	1	
8	P0005026	1	
9	P0005169	1	
10	80212525	1	
11	68109799	1	
12	P0002702	1	
13	01306599	1	
14	80000232	1	
15	P1000239	1	
16	01301599	1	
17	80001400	1	
18	86469225	8	
19	80035600	8	
20	80109200	2	
21	01300732	1	Rapid Check
22	30304432	1	Short Nail
23	01301732	1	Projecting Nail

COMPONENTS LIST

PONY FLOW 5 FUNCTIONS RAPID GUIDE



IGNITION: press any of the keys , ,  or : for an instant; you enter the Reading Menu automatically.





EXTINCTION: this function can be set as parameter in the Setting Menu, or closing the door of the display.

PARTIAL ZERO SETTING: In the Reading Menu, press the red key  4 times consecutively.

SETTING MENU: you enter the Setting Menu to verify and eventually modify the following parameters:

- PAGE 1: Language - Pulses per Liter - Unit Measure - Highlight.
- PAGE 2: Lighting time - Brightness - Extinction Time - Decimals.

Press the key  in the Reading Menu to enter page 1.
Use the keys  and  to change parameters.
Use the key  to run through the messages.

Press the key  to move from page 1 to page 2.
Use the keys  and  to change parameters.
Use the key  to run through the messages.

Press the key  to enter page 2 in the Reading Menu.

PROBLEMS, CAUSES AND CORRECTIVE

PROBLEM ENCOUNTERED	POSSIBLE CAUSE	POSSIBLE CORRECTIVE
The instrument will not turn on	The battery is completely exhausted	Replace the battery
	Power supply stopped	Check cables and connector between the battery and the electronic card
The instrument will not indicate the flow rate	Defective flowmeter sensor	Replace the sensor
	Pony Flow is not perfectly screwed onto the flowmeter	Properly screw the instrument onto the flowmeter
	Flowmeter impeller blocked	Flowmeter maintenance
The instrument will indicate a wrong flow rate	Impulses/liter value set is not correct	See chapter: "exact calculation of impulses per liter"
	Flowmeter impeller slow	Flowmeter maintenance
Will appear the battery symbol	The battery is low	Replace the battery

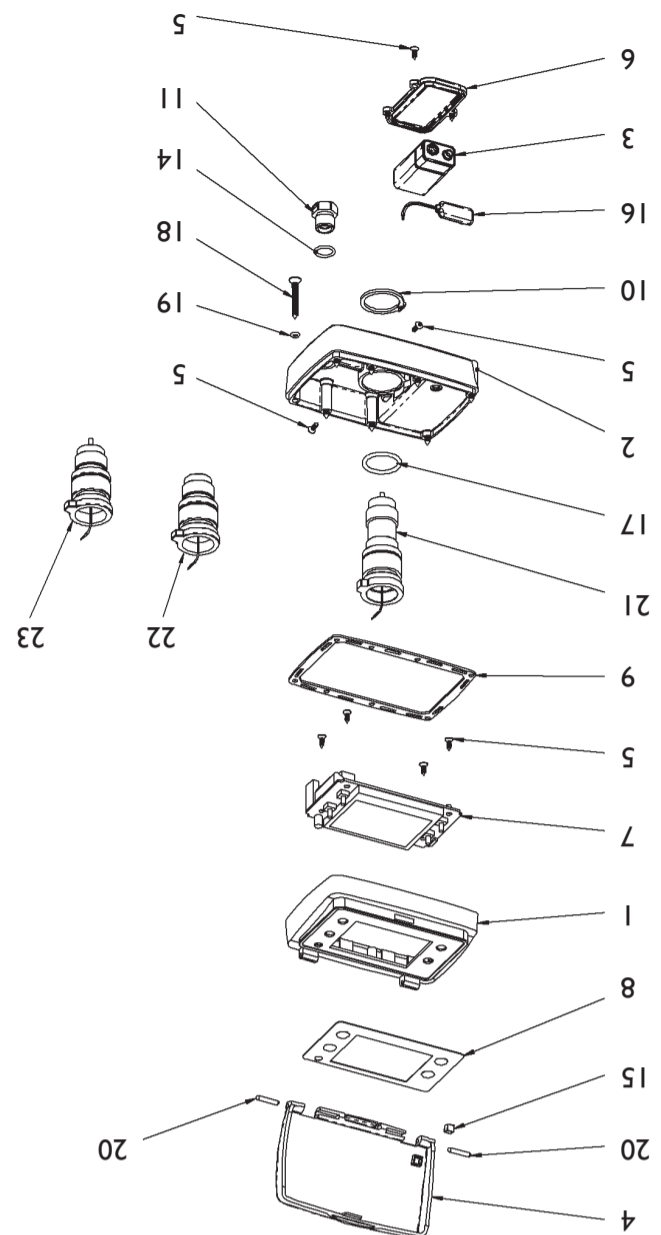

EXPL. VIEW OF THE COMPONENTS

INSTRUCTION
MANUAL

PONY FLOW 5

DISPLAY FOR MEASURING FLOW RATES

ENGLISH

PLEASE, CAREFULLY READ
THIS INSTRUCTION MANUAL
BEFORE USING THE INSTRUMENT
AND KEEP IT FOR FUTURE REFERENCE.

GUARANTEE

Our products are guaranteed for 12 months from the delivery date. Our guarantee covers all parts that are materially defective or that have manufacturing defects.

The guarantee will be considered void in the case of insufficient maintenance and improper use.

The guarantee does not cover any parts not manufactured by our company. Repairs must be made at our factory or by personnel who we have authorized.

For all service the products must be sent by freight prepaid. The labor expenses are not included in the guarantee.

Whenever you request a repair or replacement under warranty, always inform us of the instrument's serial number which is located on the adhesive label.

VERSIONS

· **Compact with Short Nail for Standard and Turbo Flow Flowmeters** (cod. 00379016) 9V battery operated with a short sinusoidal wave sensor with short nail.

(Fitting all Polmac flowmeters except Mini flowmeters and those paired to 'Compact with projecting nail').

· **Compact with Projecting Nail for Standard Flowmeters** (cod. 0037901C) 9V battery operated with a short sinusoidal wave sensor with projecting nail.

(Fitting flowmeters: 1/2" - 3" - 4" with Nylon body and 1/2" - 3/4" with stainless steel body).

· **Compact for Rapid Check Flowmeters** (cod. RC379016) 9V battery operated with square wave long sensor.

· **Remote** (cod. RE379016) 9V battery operated with remote square wave sensor (60 cm. cable).

USE

Compact: installed directly on the flowmeter.

Remote: remote connection with a turbine flowmeter with sinusoidal wave sensor.

Flow measurements of quantities of liquids obtained with the Pony Flow 5 cannot be used to determine amounts or commercial values for sale.

POWER SUPPLY

9 Volt battery (MN1604 6LR61).

Use only the type of battery indicated.

Do not throw dead batteries out in the environment but dispose inside special containers. Dead batteries do not have to be charged again.

INSTALLATION

Protected from the elements, from prolonged exposure to sunlight, and from mechanical vibrations.

IMPORTANT: high pressure washing of the exterior of this equipment could cause irreversible water damage to the electronic components. To prevent any damage, remove the display when washing the equipment's exterior.

The manufacturer declines all responsibilities for damage to the display that is the result of operator negligence.

ASSEMBLY

Pony Flow 5 must be screwed on the body of the turbine flowmeter till the bottom, without forcing. Once this operation is done, the instrument can be 270° turned till achievement of the wished position and its lower part can be fixed by means of the two screws situated in proximity to the sensor.

GENERAL FEATURES

- The instrument is turned on by the pressure of any keys or by the passage of flow;
- The display will turn off against closure of the door or automatically, once the time set in the Setting Menu under "Extinction Time" is passed;
- Back lighting of the display, activated only under no light, turn off automatically when the door is closed or automatically, once the time set in the Setting Menu under "Lighting Time" is passed; If the maximum value (600) is set on "Lighting Time" and there is flow, back lighting stay always active.
- Multifunction Display, with visualization at the same time of partial units (FLOW), total resettable units (PARTIAL) and total non resettable units (TOTAL).
- Its capacity of counting total resettable units (PARTIAL) is 4.294.967 lt., or 4.294,9 cbm/h or 1.134.734 USA gallons. Once the limit is reached, calculation starts again from zero "0".
- Its capacity of counting total non resettable units (TOTAL) is 4.294.967 lt., or 4.294,9 cbm/h, or 1.134.734 USA gallons. Once the limit is reached, calculation starts again from zero "0".
- Possibility of setting up to 6.553,5 pulses per liter.
- Reading Menu and Setting Menu.
- Set Impositions are always stored.
- Units calculation is also allowed with the protection door closed.
- Possibility of setting the reading of units with or without decimals (max. 2 decimals).
- In the Setting Menu (2 pages) the following values can be selected:

- Language
 - Pulses per liter (always set pulses per liter value, also while reading cbm/h or gallons/minute, conversion will be done automatically by the instrument)
 - Unit Measure
 - Highlight
 - Lighting Time
 - Brightness
 - Extinction Time
 - Decimals
- It accepts a sinusoidal wave signal.
 - Current input while in stand-by under 1 mA.
 - Current input while in function with 0 lighting parameter is 2 mA.
 - Current input while in function with 5 lighting parameter is 8 mA.
 - Current input while in function with 10 lighting parameter is 13 mA.
 - When the battery is exhausting a symbol of battery alarm appears on the display, on the upper right side.
 - It accepts a decimal number to set pulses/liter.

FUNCTIONING OF THE KEYS

Green key

- It can be pressed to turn on the instrument, as any other key.
- If pressed in the Reading Menu allows to enter the Setting Menu.
- If pressed in the Setting Menu at Page 1 allows to enter the Setting Menu at Page 2.
- If pressed in the Setting Menu at Page 2 allows to come back to the Reading Menu.

Red Key

- Slipping of parameters at pages 1 and 2 of the Setting Menu.
- RESET of total resettable units (PARTIAL).

Blue Key

- Change of parameter, at pages 1 and 2 of Setting Menu.

Blue Key

- Change of parameter, at pages 1 and 2 of Setting Menu.

READING MENU

Messages contained in this paragraph concerns turning of "liters" as Unit Measure. Once you have turned the instrument on, the display is in the Reading Menu.

Reading Menu displays Partial Units "Flow[l/min]", Total

Units resettable "Partial [l]" and Total Units non-resettable "Total [l]".





You can enter the Setting Menu by pressing the green key  for a while.

SETTING MENU

It provides 8 parameters on 2 pages:



- PAGE 1
- Setting of the language: Italian, English, French, Deutsch, Spanish, Portuguese, Russian, Polish.
 - Setting of pulses per liter.
 - Setting of Unit Measure: Liter/min. – Cubic meter/H – Gallons/min.
 - Setting of reading at the centre of the display in the Reading Menu: Partial Units - Total – Flow.
- PAGE 2
- Setting of Lighting Time (max. 600 seconds).
 - Setting of Brightness (from 0 to 10).
 - Setting of Extinction Time (max. 600 seconds).
 - Setting of number of decimals (0 - 0,0 - 0,00) displayed in the Reading Menu.

OPERATIVE PHASE:

- Turn the instrument on;
- Press the green key  to enter the Setting Menu, page 1;
- Select the language wished by pressing the blue keys  and ;
- Press the red key  to allow direct passage to next message.

- Press the keys  and  to set pulses per liter;
- Press the red key  to allow direct passage to next parameter.

- Press the keys  and  to select the Unit Measure;
- Press the red key  to allow direct passage to next parameter.

- Press the keys  and  to select the parameter in the Reading Menu;
- Press the green key  to enter the Setting Menu, page 2;

- Set the Lighting Time, while turning the instrument on or by pressing any key;
- Press the red key  to allow direct passage to next parameter.

6a) Set the brightness of the display (selectable value from 0 to 10); a lower value allows battery's stronger life duration;

6b) Press the red key  to allow direct passage to next parameter.

7a) Set the Extinction Time (seconds); calculation is stored and operative while the display is switched off.

7b) Press the red key  to allow direct passage to next parameter.

8a) Setting of decimals for values displayed in the Reading Menu (values available: 0 - 1 - 2).

8b) Press the green key  to come back to the Reading Menu.

RESETTING THE TOTAL TO ZERO (RESET)

To reset the total "Partial [l]" in the Reading Menu, press the red key  4 times consecutively.

The value: "Total [l]" is not resettable.

EXACT CALCULATION OF IMPULSES PER LITER

Each flowmeter is delivered with an identification plate which lists an indication of the number of impulses per liter. This total value can be increased or decreased depending on the type of application and the use of the flowmeter.

It is indispensable to always perform a comparison between the displayed total and the amount of liquid that is actually delivered, so as to calculate the exact number of impulses to be used to calibrate the instrument.

This comparison must be performed with new flowmeter and periodically thereafter.

Example:

the liquid displayed by the instrument is: 55 liters;

The amount of liquid that is actually delivered by the instrument is: 57 liters;

The instrument is: 57 liters;

The set calibration constant "C" is: 650;

An analysis of this data shows that it is necessary to modify the set calibration constant "C" by means of the following formula: $650 \times 55 : 57 = 627$

(new value of impulses per liter to set).

1) When the displayed value is less than the actual value (delivered), you need to decrease the set value of "impulses per liter".

2) When the displayed value is greater than the actual value (delivered), you need to increase the set value of "impulses per liter".

REMARKS: set value is always liter/minute. The instrument does the conversion automatically, should the unit measure be different: "cubic meter/hour" o "Gallons per minute".

GENERAL MAINTENANCE RULES

Keep the instruments protected from the elements.

Avoid extreme temperature, direct sunlight, and direct contact with water, especially while washing the equipment with water under high pressure.

In the case of battery-powered instruments immediately replace the batteries or remove them from their compartment when they are exhausted.

Press the keys carefully.

SPECIFICATIONS

Dimension of standard version, sensor included (mm.): 120×80×86.

Dimension of Rapid Check version, sensor included (mm.): 120×80×110.

Dimensions of Standard and Rapid Check versions, excluding the part of sensor screwed on the flowmeter (mm.): 120×80×65.

Weight of standard version (gr.): 320.

Weight of Rapid Check version (gr.): 335.

Accuracy: ± 1%.

Battery: 9 volt transistor MN 1604 6LR61.

Optimal operating temperature range: from -10° to +70°.

Not condensed relevant humidity max. 90° (with no tropicalization).

TO ORDER SPARE PARTS, SPECIFY THE FOLLOWING:

- Series number of the display
- Code number of the part to be replaced
- Quantity
- Shipping desired

CHANGING THE 9 VOLTS BATTERY

- Unscrew the screws (1)
- Remove the cover (2)
- Remove the battery (4) by unsnapping it from the contacts (3)
- Clean the contacts (3) to eventual oxidation
- Replace it with a new battery
- Close the Pony Flow with the cover (2) and the screws (1)

